

Controsoffitti in metallo



custom size

# METAL MESH HOOK ON PLUS 900 system



**CBI**  
EUROPE  
HI-TECH INTERIORS

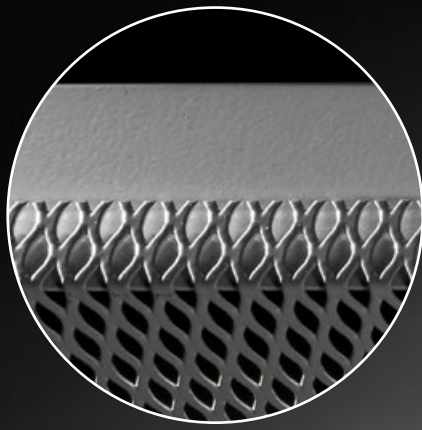

**A perfect combination  
of technology  
and design: versatile,  
functional, simple.**

---

The steel reinforcing band allows the creation of large panels, which can be installed quickly, safely and stably.

CBI Europe technology at the service the most advanced interior design, for solutions that are always innovative.

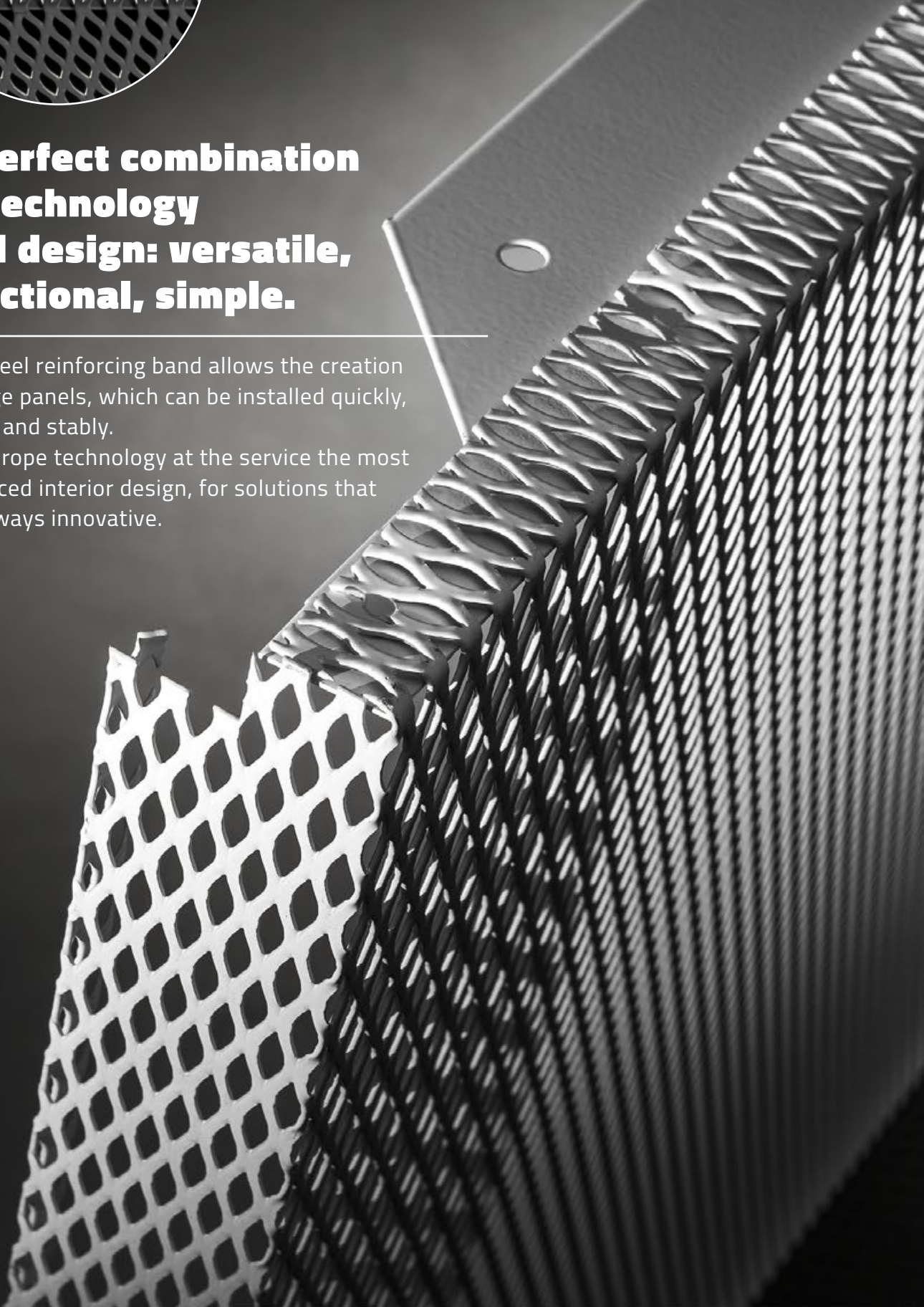

# MX900XX HOOK ON PLUS 900 SYSTEM



CUSTOM SIZE

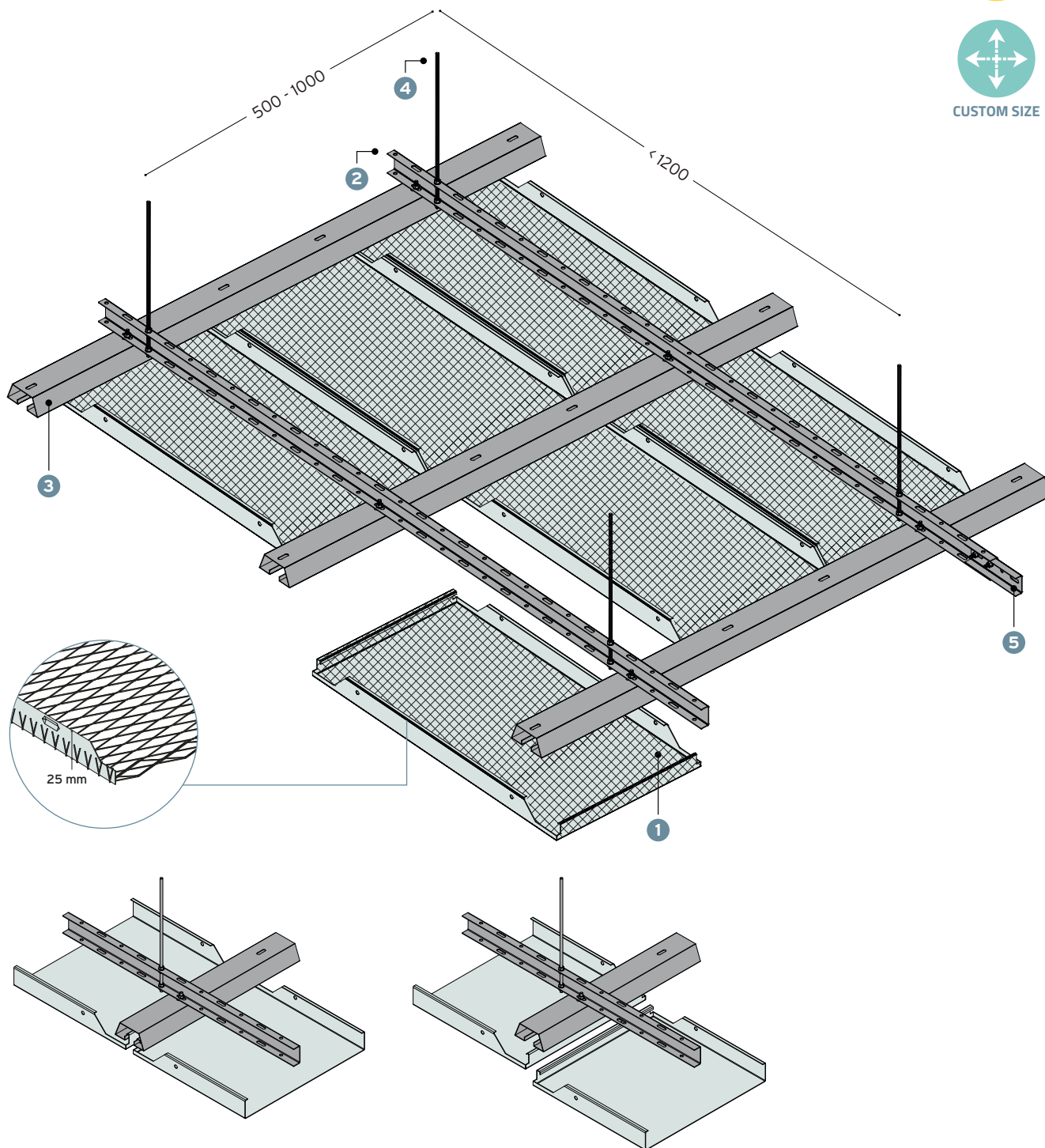

1

**MX900XX** panel  
pannello

2

**C3810P** primary profile  
profilo primario

3

**P900** main runner profile  
profilo portante

4

hanger bracket  
attacco di sospensione

5

**GC3810P** joint for primary  
profile  
giunto per profilo  
primario

**GU 600** 1.5 mm gasket to hide edges  
guarnizione autoadesiva di 1.5 mm  
per il mascheramento degli spigoli  
(optional)

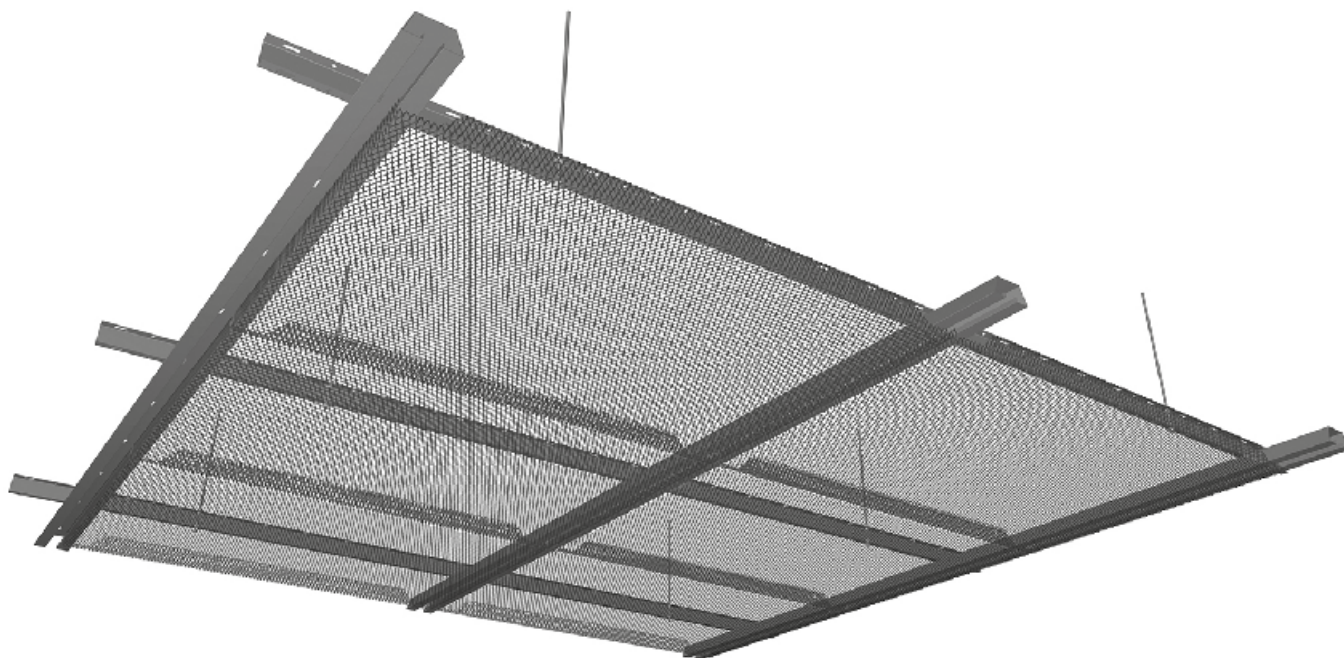

**MX900XX** square edge  
bordo angolo vivo



CUSTOM SIZE

width larghezza 300 mm > 600 mm  
length lunghezza 600 mm > 2400 mm

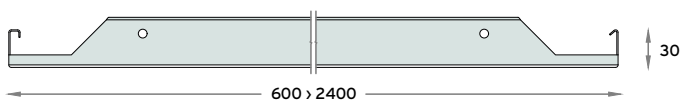
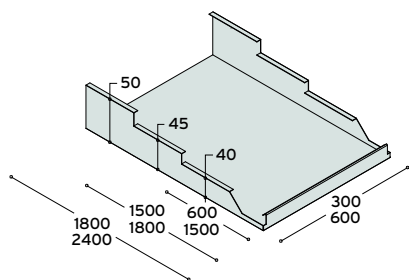
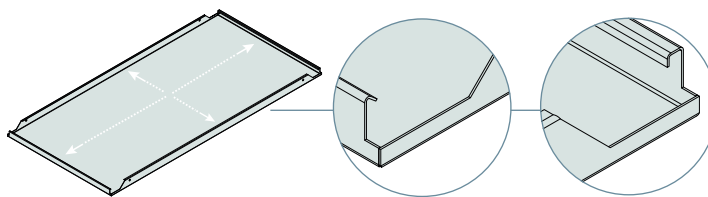

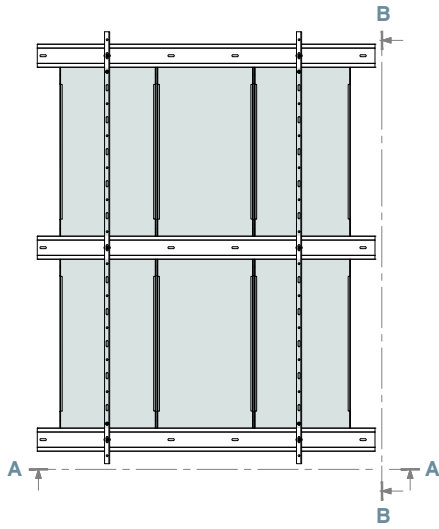

SEZ. A-A

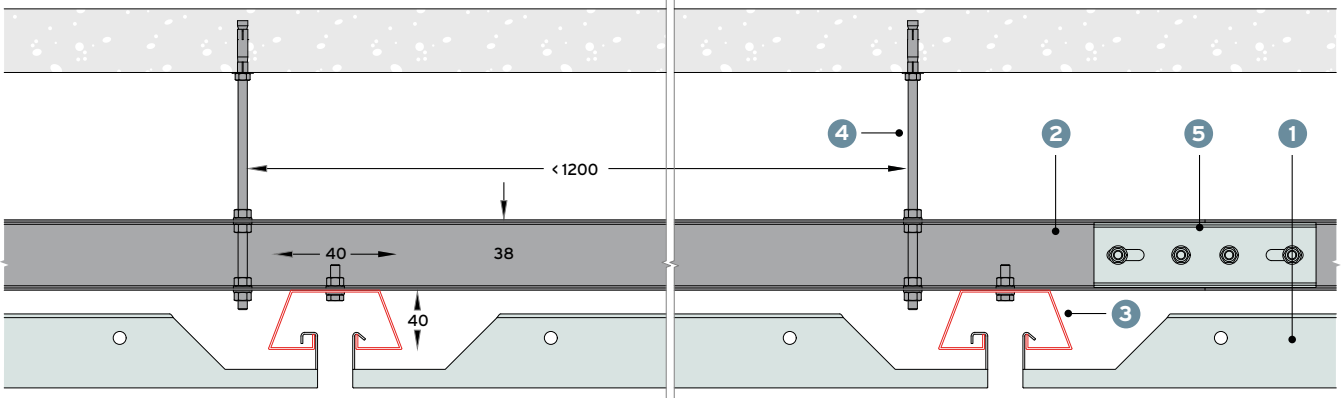

SEZ. B-B

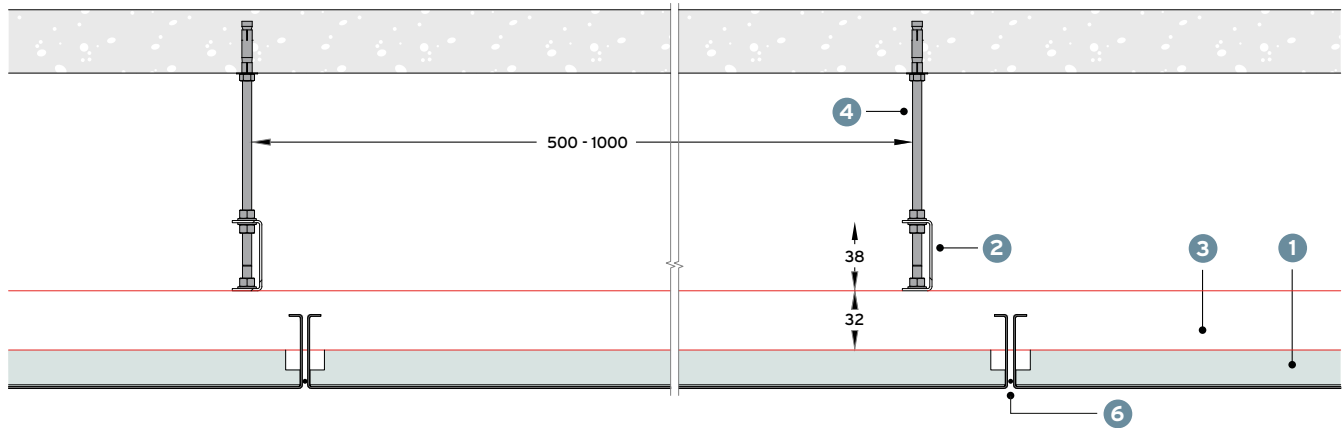

<b>1</b>	<b>2</b>	<b>3</b>	<b>4</b>
<b>MX900XX</b> panel pannello	<b>C3810P</b> primary profile profilo primario	<b>P900</b> main runner profile profilo portante	hanger bracket attacco di sospensione
<b>5</b>	<b>6</b>		
<b>GC3810P</b> joint for primary profile giunto per profilo primario	<b>GU 600</b> 1.5 mm gasket to hide edges guarnizione autoadesiva di 1.5 mm per il mascheramento degli spigoli (optional)		

# METAL MESH LAMIERA STIRATA

## DIMENSIONS DIMENSIONI

**DL** long diagonal · diagonale lunga  
**DC** short diagonal · diagonale corta  
**av** advancement · avanzamento  
**sp** thickness · spessore

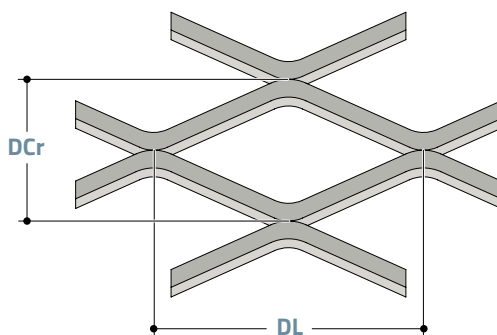

section sezione

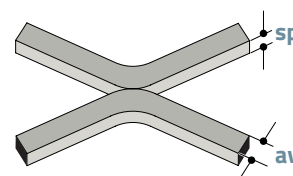

code codice	description descrizione	DL long diagonal diagonale lunga	DC short diagonal diagonale corta	av advancement avanzamento	sp thickness spessore	% perforation foratura
<b>CBI ST10</b>	RHOMBOIDAL MESH · MAGLIA ROMBOIDALE	16 mm	8 mm	2 mm	1 mm	<b>50 %</b>
<b>CBI ST11</b>	RHOMBOIDAL MESH · MAGLIA ROMBOIDALE	28 mm	10 mm	1,5 mm	1 mm	<b>70 %</b>
<b>CBI ST12</b>	RHOMBOIDAL MESH · MAGLIA ROMBOIDALE	43 mm	14 mm	2,5 mm	1 mm	<b>64 %</b>

## CERTIFICATIONS CERTIFICAZIONI

<b>Durability of galvanized items</b> <i>Durabilità zincati</i>	<b>class B</b>	<b>Release of dangerous substances</b> <i>Emissione sostanze pericolose</i>	<b>none</b>
<b>CORROSION RESISTANCE · REAZIONE ALLA CORROSIONE</b>			
Galvanised steel products <i>Prodotti in acciaio zincato</i>	<b>C2</b>	Pre-painted galvanised steel products <i>Prodotti in acciaio zincato pre-verniciato</i>	<b>C3</b>
Post-painted galvanised steel products <i>Prodotti in acciaio zincato post-verniciato</i>	<b>C4</b>	Pre and post-painted aluminum products <i>Prodotti in alluminio pre o post-verniciato</i>	<b>C5</b>

## FINSHES FINITURE

### POWDER COATED

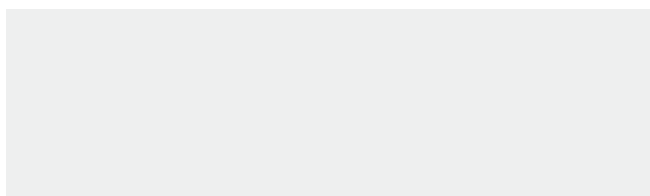

**RAL 9003**  
white · bianco



**RAL 9006**  
silver · argento

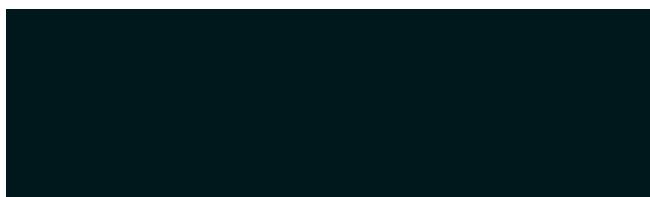

**RAL 9005**  
black · nero

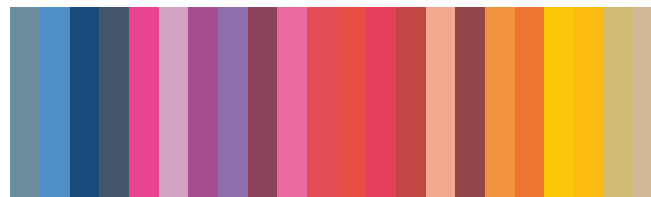

All RAL colours · tutti i colori RAL

## METAL MESH LAMIERA STIRATA

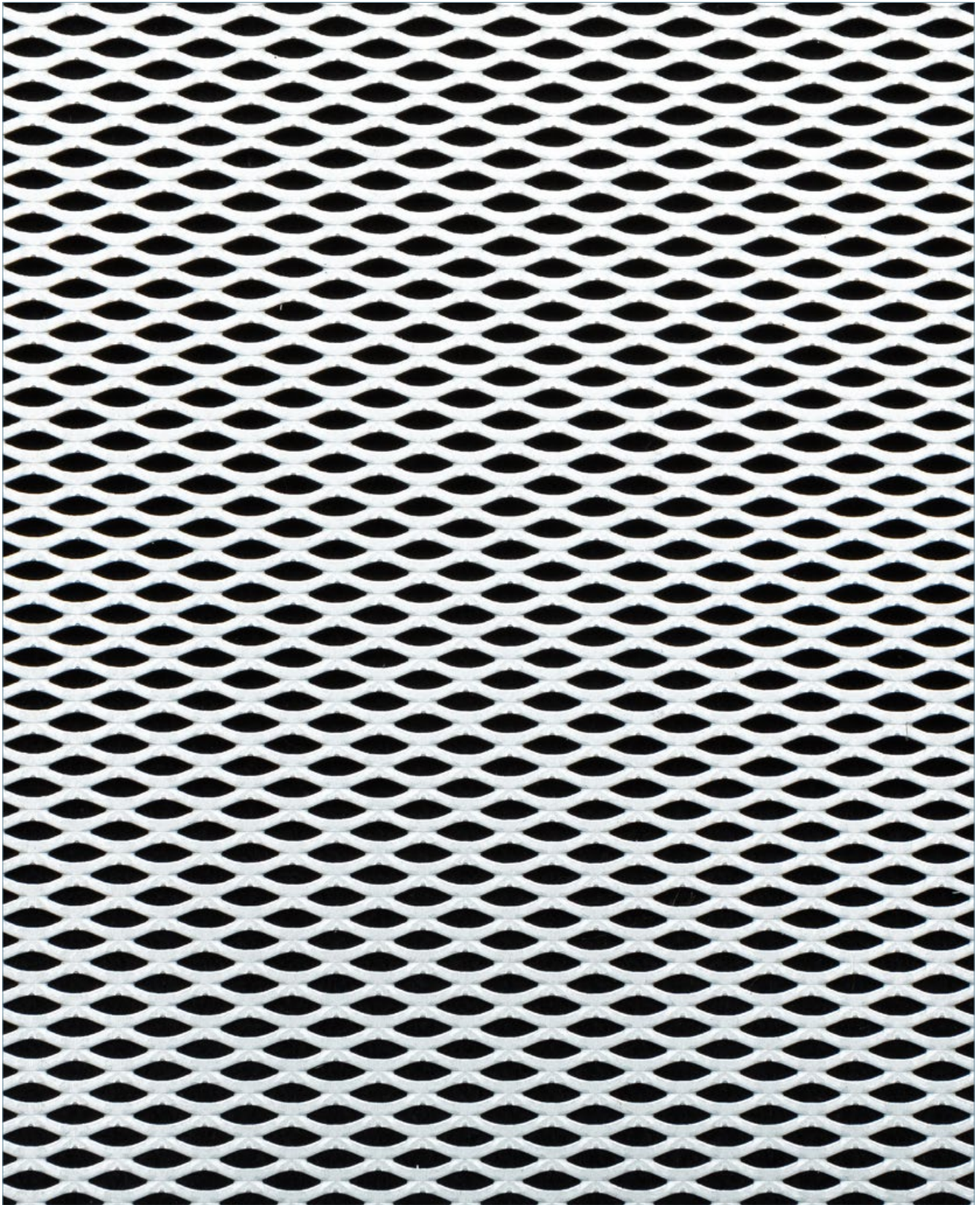

**CBI ST10** Post-painted galvanised steel powder coated  
*Acciaio zincato post-verniciato powder coated*

**DL 16 mm**  
**DC 8 mm**

**av 2 mm**  
**sp 1 mm**

**perforation foratura 50 %**

## METAL MESH LAMIERA STIRATA



**CBI ST11** Post-painted galvanised steel powder coated  
*Acciaio zincato post-verniciato powder coated*

**DL 28 mm**  
**DC 10 mm**

**av 1,5 mm**  
**sp 1 mm**

**perforation foratura 70 %**



## METAL MESH LAMIERA STIRATA

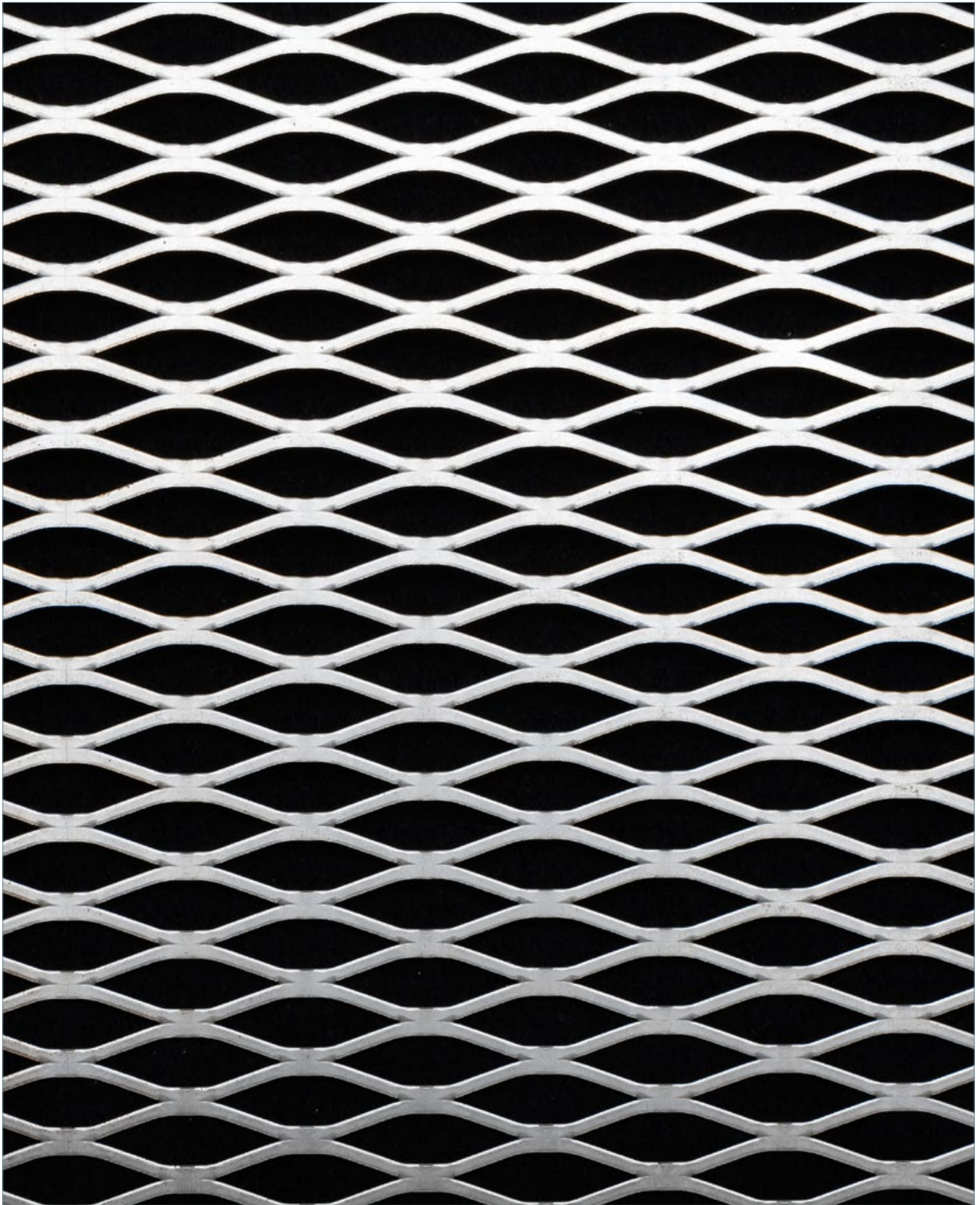

**CBI ST12** Post-painted galvanised steel powder coated  
*Acciaio zincato post-verniciato power coated*

**DL 43 mm**    **av 2,5 mm**    **perforation foratura 64 %**  
**DC 14 mm**    **sp 1 mm**

# METAL MESH LAMIERA STIRATA

## PERIMETRAL MOLDING CORNICI PERIMETRALI

standard width *larghezza standard* 3000 mm

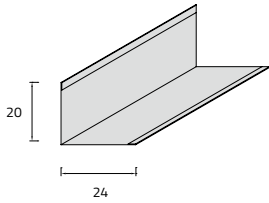

**20 X 24**

CP10 aluminum ■ *alluminio* 0.5/0.6 mm  
A3000 steel ■ *acciaio* 0.4/0.5 mm

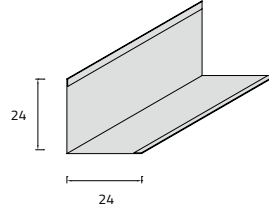

**24 X 24**

CP10/1 aluminum ■ *alluminio* 0.5/0.6 mm  
A3001 steel ■ *acciaio* 0.4/0.5 mm

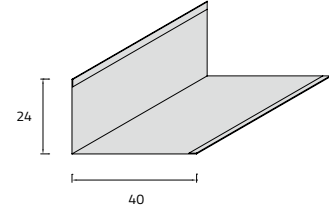

**40 X 24**

CP50 aluminum ■ *alluminio* 0.5/0.6 mm  
A3002 steel ■ *acciaio* 0.5 mm

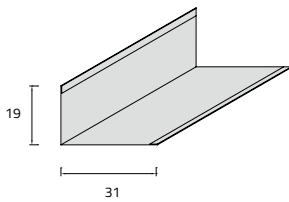

**31 X 19**

CP60 aluminum ■ *alluminio* 0.5/0.6 mm  
A3003 steel ■ *acciaio* 0.5 mm

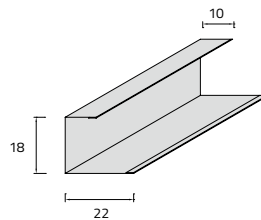

**22 X 18 X 10**

CP 30 aluminum ■ *alluminio* 0.5 mm  
CP 40 steel ■ *acciaio* 0.4 mm

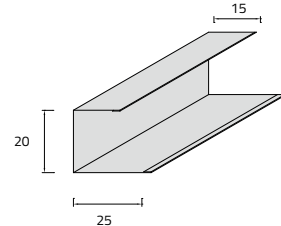

**25 X 20 X 15**

CP 80 aluminum ■ *alluminio* 0.5 mm  
CP 80 steel ■ *acciaio* 0.4 mm

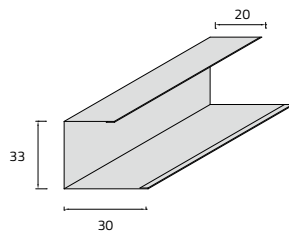

**30 X 33 X 20**

CP 90 aluminum ■ *alluminio* 0.6/0.8 mm  
CP 90 steel ■ *acciaio* 0.6 mm

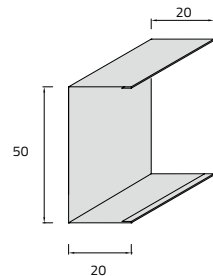

**20 X 50 X 20**

U5020/AL aluminum ■ *alluminio* 0.5/0.6 mm  
U3001 steel ■ *acciaio* 0.5 mm

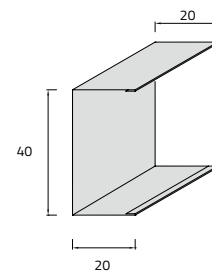

**20 X 40 X 20**

U4020 aluminum ■ *alluminio* 0.5/0.6 mm  
U3000 steel ■ *acciaio* 0.4/0.5 mm

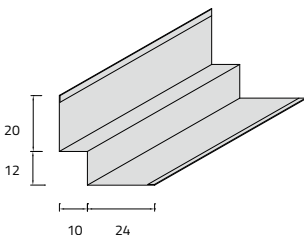

**24 + 10 X 12 + 20**

CF 10 aluminum ■ *alluminio* 0.5 mm  
W3000 steel ■ *acciaio* 0.5 mm

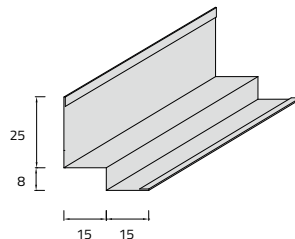

**15 + 15 X 8 + 25**

-  
W3002 steel ■ *acciaio* 0.5 mm

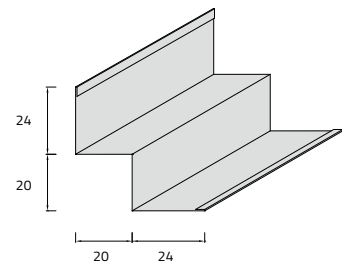

**24 - 20 X 20 + 24**

-  
W3003 steel ■ *acciaio* 0.5 mm

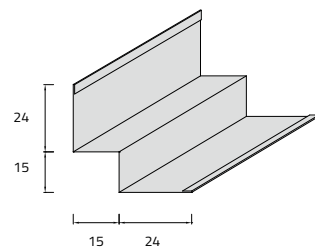

**24 + 15 X 15 + 24**

-  
W3004 steel ■ *acciaio* 0.5 mm

# METAL CEILINGS AND COVERINGS: design and functionality, 100% made in Italy.

CBI Europe's Linear Strips suspended ceiling system is the perfect solution for civil and industrial buildings. These highly functional architectural elements combine thermal and acoustic insulation with the ability

to integrate ventilation, lighting and security systems. The fully inspectable strips come in various modular types and designs to allow the suspended ceiling to adapt to all spaces and layouts.

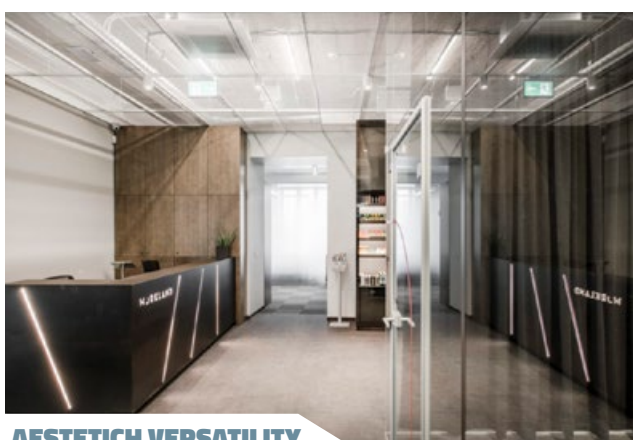

**AESTETICH VERSATILITY**



**LIMITLESS CONFIGURATION**

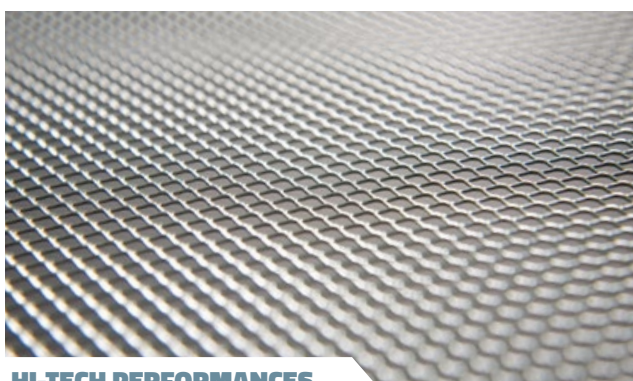

**HI-TECH PERFORMANCES**

## Why

**VERSATILE, FUNCTIONAL, LONG LASTING AND EASY TO INSTALL: A PERFECT COMBINATION OF TECHNOLOGY AND DESIGN THAT GUARANTEES HYGIENE AND STRENGTH.**

## Where

**LARGE PUBLIC SPACES - HALLS, SHOPPING CENTRES, AIRPORTS, BANKS, OFFICES, CORRIDORS, STERILE ENVIRONMENTS, THEATRES, CANTEENS, HOSPITALS - OUTDOORS AND INDOORS.**

## Benefit

- **ACHIEVING FLEXIBLE, COMFORTABLE, CONTEMPORARY AND RESPONSIBLE INTERIORS.**
- **OBTAINING POINTS FOR LEED CERTIFICATION.**
- **SOUNDPROOFED ENVIRONMENTS.**
- **SPEEDING UP CONSTRUCTION.**
- **CONTAINING COSTS OF LABOUR AND MAINTENANCE.**
- **STRUCTURES 100% INSPECTABLE.**
- **INTEGRATION WITH ADVANCED CLIMATE CONTROL, DOMOTICS AND LIGHTING.**
- **PRECISE BUDGETING.**



### FIRE REACTION

Including versions incorporating sound-absorbing non-woven fabric, are non-flammable according to the Italian Ministerial Decree of the 15th march 2005, and therefore conform to Euroclass A1 fire reaction requirements (only for not perforated panels).



### HYGIENE

Easy to wash and sterilise. On request, they can also be supplied in a special fungicidal and bactericidal paint finish. We recommend hermetically sealed, Down Clip 200 System Metal Ceilings for use in operating theatres and pharmaceutical industries. All other types of metal suspended ceilings are ideal for use in kitchens, canteens, hospitals and schools. They also provide valuable protection against dust in industries producing delicate electronic circuits. Tests carried out under ISO 22196 ensure the reduction of the microbial population > 95% after 24 hours.



### HUMIDITY RESISTANCE

Maintain their dimensional stability even under extreme ambient conditions, and can therefore be installed in environments characterised by high levels of relative humidity and large variations in temperature. For outdoor installations, please contact CBI Europe's Technical Department.



### PAINTWORK

Suspended ceilings in pre-painted aluminium and hot-galvanised and pre-painted FePO2 steel are coil-coated with primer and polyester paint to a thickness of 25 microns. Suspended ceilings in electro-galvanised and post-painted FePO2 steel are electrostatically coated with resin based, thermosetting, polyester powder paints to a thickness of 60 microns.



### LIGHT REFLECTANCE

All metal suspended ceilings finished in white and unperforated > 85% have a standard gloss level of 20.



### INTEGRATED ACCESSORIES

All metal suspended ceilings can be fitted with accessories such as lighting units, ventilation vents, smoke detectors, sprinklers and suspended signage



### FASTNESS

The systems are designed to guarantee rapid installation, speeding up the installation phases and respecting all the requirements of planarity and orthogonality.



### ACOUSTIC ABSORPTION

Ceilings and coverings combine acoustic performance, comfort and aesthetics with adequate absorption values. Upon request they can be supplied with certifications issued by independent companies.



### LEED CERTIFICATION

All products are manufactured in certified and constantly monitored processes to guarantee the highest standards of quality and safety.



### ANTI-SEISMIC

The systems guarantee the application of all good safety practices in the construction and development of dedicated projects. Upon request, they can be supplied with an anti-seismic reports, which indicate suitable bracing.

#### CBI EUROPE

Via Mons. A.O. Romero, 14 · 60027 Osimo (AN) Italy  
T +39 071 71 08 688 · fax +39 071 71 08 63  
info@cbi-europe.com · www.cbi-europe.com



S-P-05361 EPD®  
environdec.com

