

Linear strips

CUBIC EDGE system

 **CBI**
EUROPE
HI-TECH INTERIORS

CUBIC EDGE LINEAR STRIPS SYSTEM

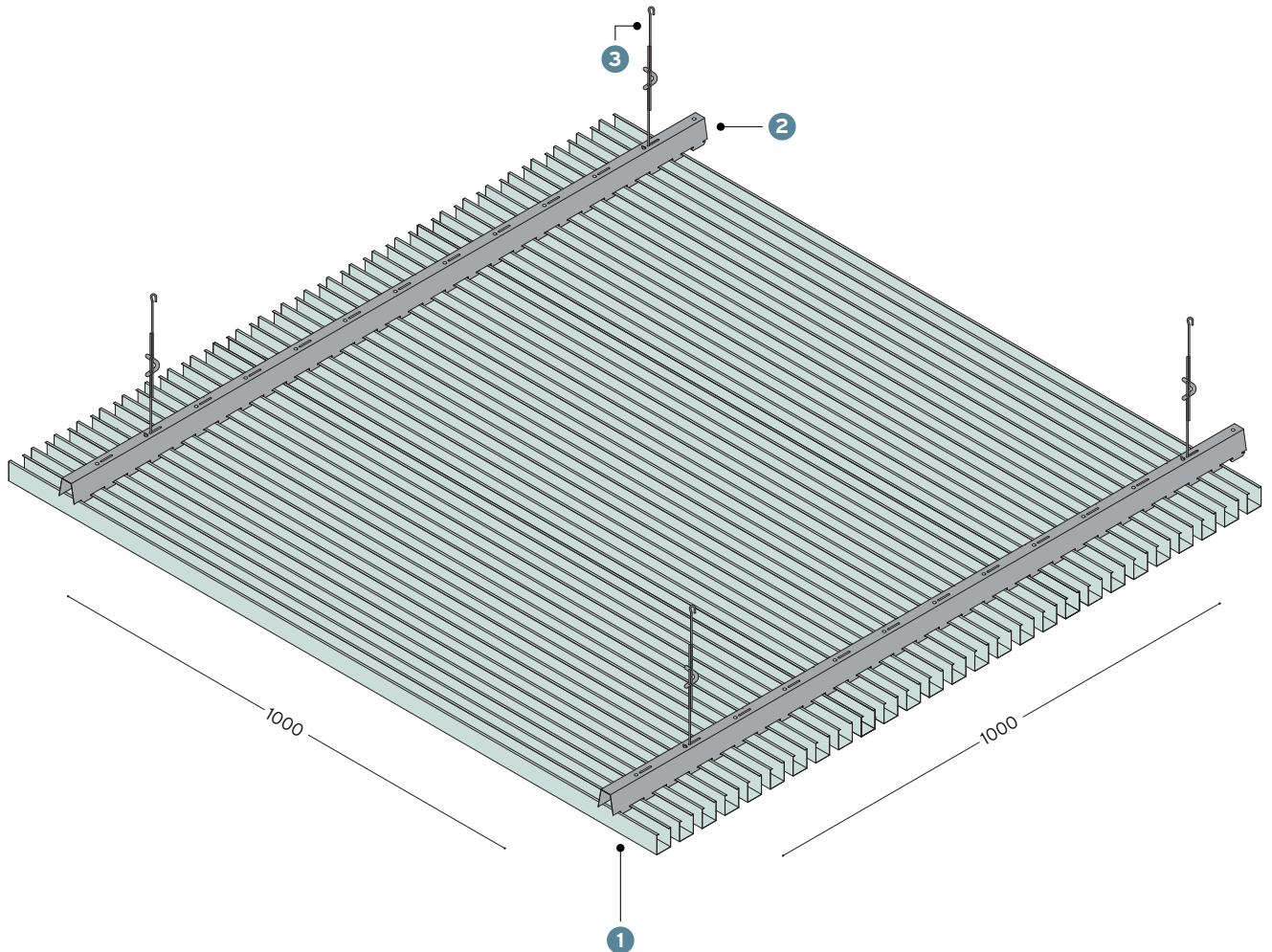

STRIP DOGA

L 9000 mm max



H 15 mm
open joint
scuretto aperto



closed joint
scuretto chiuso



H 38 mm
open joint
scuretto aperto

preainted aluminium
alluminio preverniciato
thk sp. 0.5 - 0.6 - 0.7 - 0.8 mm

preainted galvanized steel
acciaio zincato preverniciato
thk sp. 0.4 - 0.5 - 0.6 mm

MAIN RUNNER PROFILO PORTANTE

L 4000 mm

T UNI

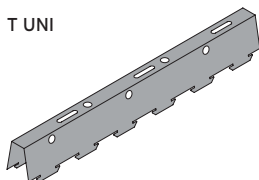

galvanized steel
acciaio zincato
thk sp. 0.6 mm

colour colore
brown testa di moro

PC/UNI

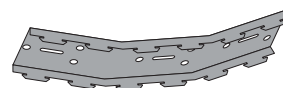

galvanized steel
acciaio zincato
thk sp. 0.6 mm

colour colore
black nero

1

strip
doga
length lunghezza
9000 mm max

2

carrier
profilo portante

3

adjustable suspension
sospensione regolabile

BASE 50 mm STRIPS / OPEN JOINT DOGHE / SCURETTO APERTO		MAIN RUNNERS _ PROFILI PORTANTI	
code _ codice	type _ tipo	code _ codice	thickness _ spessore colour _ colore

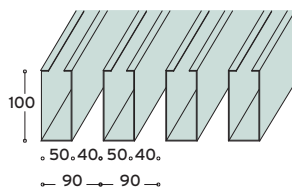
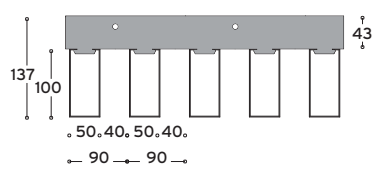
ST050A1 	metal strips pitch 90 mm open joint doghe passo 90 mm scuretto aperto	T UNI 	galvanized steel 0.6 brown acciaio zincato 0.6 testa di moro														
	<table border="1"> <thead> <tr> <th>size</th> <th>dimensioni</th> <th>incidence</th> <th>incidenza</th> </tr> </thead> <tbody> <tr> <td>50x100 mm</td> <td></td> <td>11.11 ml/mq</td> <td></td> </tr> </tbody> </table>		size	dimensioni	incidence	incidenza	50x100 mm		11.11 ml/mq		<table border="1"> <thead> <tr> <th>length</th> <th>lunghezza</th> <th>incidence</th> <th>incidenza</th> </tr> </thead> <tbody> <tr> <td>4000 mm</td> <td></td> <td>0.9 ml/mq</td> <td></td> </tr> </tbody> </table> <p>pcs_pz : 10</p>	length	lunghezza	incidence	incidenza	4000 mm	
size	dimensioni	incidence	incidenza														
50x100 mm		11.11 ml/mq															
length	lunghezza	incidence	incidenza														
4000 mm		0.9 ml/mq															

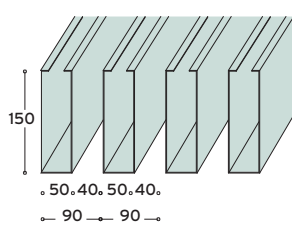
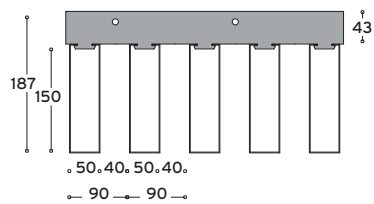
ST050A2 	metal strips pitch 90 mm open joint doghe passo 90 mm scuretto aperto	T UNI 	galvanized steel 0.6 brown acciaio zincato 0.6 testa di moro														
	<table border="1"> <thead> <tr> <th>size</th> <th>dimensioni</th> <th>incidence</th> <th>incidenza</th> </tr> </thead> <tbody> <tr> <td>50x150 mm</td> <td></td> <td>11.11 ml/mq</td> <td></td> </tr> </tbody> </table>		size	dimensioni	incidence	incidenza	50x150 mm		11.11 ml/mq		<table border="1"> <thead> <tr> <th>length</th> <th>lunghezza</th> <th>incidence</th> <th>incidenza</th> </tr> </thead> <tbody> <tr> <td>4000 mm</td> <td></td> <td>0.9 ml/mq</td> <td></td> </tr> </tbody> </table> <p>pcs_pz : 10</p>	length	lunghezza	incidence	incidenza	4000 mm	
size	dimensioni	incidence	incidenza														
50x150 mm		11.11 ml/mq															
length	lunghezza	incidence	incidenza														
4000 mm		0.9 ml/mq															

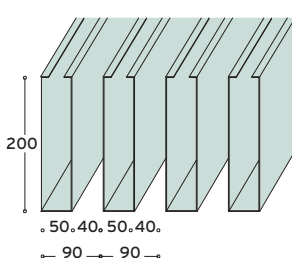
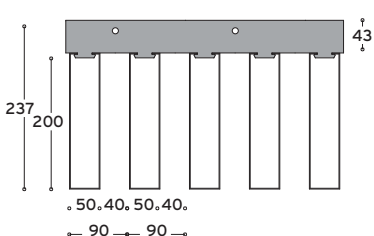
ST050A3 	metal strips pitch 90 mm open joint doghe passo 90 mm scuretto aperto	T UNI 	galvanized steel 0.6 brown acciaio zincato 0.6 testa di moro														
	<table border="1"> <thead> <tr> <th>size</th> <th>dimensioni</th> <th>incidence</th> <th>incidenza</th> </tr> </thead> <tbody> <tr> <td>50x200 mm</td> <td></td> <td>11.11 ml/mq</td> <td></td> </tr> </tbody> </table>		size	dimensioni	incidence	incidenza	50x200 mm		11.11 ml/mq		<table border="1"> <thead> <tr> <th>length</th> <th>lunghezza</th> <th>incidence</th> <th>incidenza</th> </tr> </thead> <tbody> <tr> <td>4000 mm</td> <td></td> <td>0.9 ml/mq</td> <td></td> </tr> </tbody> </table> <p>pcs_pz : 10</p>	length	lunghezza	incidence	incidenza	4000 mm	
size	dimensioni	incidence	incidenza														
50x200 mm		11.11 ml/mq															
length	lunghezza	incidence	incidenza														
4000 mm		0.9 ml/mq															

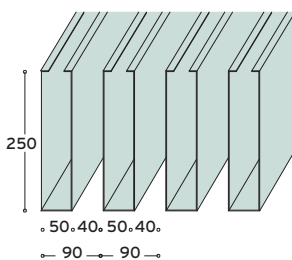
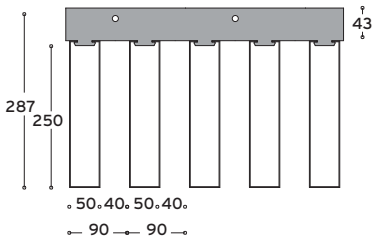
ST050A4 	metal strips pitch 90 mm open joint doghe passo 90 mm scuretto aperto	T UNI 	galvanized steel 0.6 brown acciaio zincato 0.6 testa di moro														
	<table border="1"> <thead> <tr> <th>size</th> <th>dimensioni</th> <th>incidence</th> <th>incidenza</th> </tr> </thead> <tbody> <tr> <td>50x200 mm</td> <td></td> <td>11.11 ml/mq</td> <td></td> </tr> </tbody> </table>		size	dimensioni	incidence	incidenza	50x200 mm		11.11 ml/mq		<table border="1"> <thead> <tr> <th>length</th> <th>lunghezza</th> <th>incidence</th> <th>incidenza</th> </tr> </thead> <tbody> <tr> <td>4000 mm</td> <td></td> <td>0.9 ml/mq</td> <td></td> </tr> </tbody> </table> <p>pcs_pz : 10</p>	length	lunghezza	incidence	incidenza	4000 mm	
size	dimensioni	incidence	incidenza														
50x200 mm		11.11 ml/mq															
length	lunghezza	incidence	incidenza														
4000 mm		0.9 ml/mq															

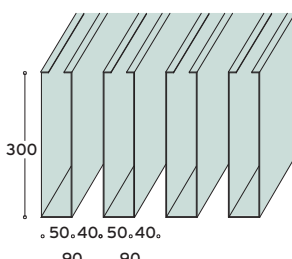
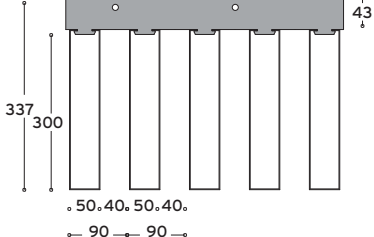
ST050A5 	metal strips pitch 90 mm open joint doghe passo 90 mm scuretto aperto	T UNI 	galvanized steel 0.6 brown acciaio zincato 0.6 testa di moro														
	<table border="1"> <thead> <tr> <th>size</th> <th>dimensioni</th> <th>incidence</th> <th>incidenza</th> </tr> </thead> <tbody> <tr> <td>50x200 mm</td> <td></td> <td>11.11 ml/mq</td> <td></td> </tr> </tbody> </table>		size	dimensioni	incidence	incidenza	50x200 mm		11.11 ml/mq		<table border="1"> <thead> <tr> <th>length</th> <th>lunghezza</th> <th>incidence</th> <th>incidenza</th> </tr> </thead> <tbody> <tr> <td>4000 mm</td> <td></td> <td>0.9 ml/mq</td> <td></td> </tr> </tbody> </table> <p>pcs_pz : 10</p>	length	lunghezza	incidence	incidenza	4000 mm	
size	dimensioni	incidence	incidenza														
50x200 mm		11.11 ml/mq															
length	lunghezza	incidence	incidenza														
4000 mm		0.9 ml/mq															

closing caps in aluminium and steel · chiusura terminale alluminio e acciaio

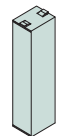
- for per
- ST050A1** › TAP 100/50
 - ST050A2** › TAP 150/50
 - ST050A3** › TAP 200/50
 - ST050A4** › TAP 250/50
 - ST050A5** › TAP 300/50
- 

linear joint · giunto lineare aluminium alluminio 0.5 mm · L 500 mm

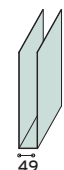
- for per
- ST050A1** › GL 100/50
 - ST050A2** › GL 150/50
 - ST050A3** › GL 200/50
 - ST050A4** › GL 250/50
 - ST050A5** › GL 300/50
- 

STRIPS / OPEN JOINT DOGHE / SCURETTO APERTO		MAIN RUNNERS _ PROFILI PORTANTI	
code _ codice	type _ tipo	code _ codice	thickness _ spessore colour _ colore
ST030AA	metal strips pitch 50 mm open joint doghe passo 50 mm scuretto aperto size dimensioni incidence incidenza 30x38 mm 20 ml/mq	T UNI 	galvanized steel 0.6 brown acciaio zincato 0.6 testa di moro length lunghezza incidence incidenza 4000 mm 0.9 ml/mq pcs_pz : 10
ST030AR	metal strips pitch 50 mm open joint doghe passo 50 mm scuretto aperto size dimensioni incidence incidenza 30x15 mm 20 ml/mq	T UNI 	galvanized steel 0.6 brown acciaio zincato 0.6 testa di moro length lunghezza incidence incidenza 4000 mm 0.9 ml/mq pcs_pz : 10
ST080AA	metal strips pitch 100 mm open joint doghe passo 100 mm scuretto aperto size dimensioni incidence incidenza 80x15 mm 10 ml/mq	T UNI 	galvanized steel 0.6 brown acciaio zincato 0.6 testa di moro length lunghezza incidence incidenza 4000 mm 0.9 ml/mq pcs_pz : 10
ST130AA	metal strips pitch 150 mm open joint doghe passo 150 mm scuretto aperto size dimensioni incidence incidenza 130x15 mm 6.67 ml/mq	T UNI 	galvanized steel 0.6 brown acciaio zincato 0.6 testa di moro length lunghezza incidence incidenza 4000 mm 0.9 ml/mq pcs_pz : 10
ST180AA	metal strips pitch 200 mm open joint doghe passo 200 mm scuretto aperto size dimensioni incidence incidenza 180x15 mm 5 ml/mq	T UNI 	galvanized steel 0.6 brown acciaio zincato 0.6 testa di moro length lunghezza incidence incidenza 4000 mm 0.9 ml/mq pcs_pz : 10
ST080CC	metal strips pitch 100 mm closed joint doghe passo 100 mm scuretto chiuso size dimensioni incidence incidenza 80x15 mm 10 ml/mq	T UNI 	galvanized steel 0.6 brown acciaio zincato 0.6 testa di moro length lunghezza incidence incidenza 4000 mm 0.9 ml/mq pcs_pz : 10
ST130CC	strips pitch 150 mm closed joint doghe passo 150 mm scuretto chiuso size dimensioni incidence incidenza 130x15 mm 6.67 ml/mq	T UNI 	galvanized steel 0.6 brown acciaio zincato 0.6 testa di moro length lunghezza incidence incidenza 4000 mm 0.9 ml/mq pcs_pz : 10
ST180CC	strips pitch 200 mm closed joint doghe passo 200 mm scuretto chiuso size dimensioni incidence incidenza 180x15 mm 5 ml/mq	T UNI 	galvanized steel 0.6 brown acciaio zincato 0.6 testa di moro length lunghezza incidence incidenza 4000 mm 0.9 ml/mq pcs_pz : 10

INDOOR LINEAR STRIPS *DOGHE LINEARI PER INTERNI* PERFORATION PANELS *FORATURE PANNELLI*

standard width *larghezza standard* < 600 mm

● perforation *forature*

MICRO PERFORATION *MICRO FORATURE*

H - AP0/1

Ø 0.7 mm - parallel pitch ▪ *passo parallelo* 5 mm

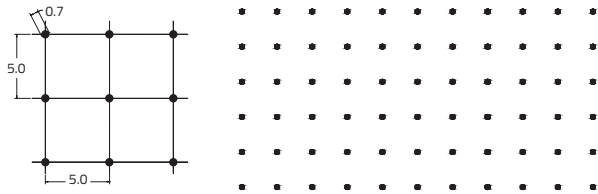

I - AP0/2

Ø 0.7 mm - parallel pitch ▪ *passo parallelo* 5 mm

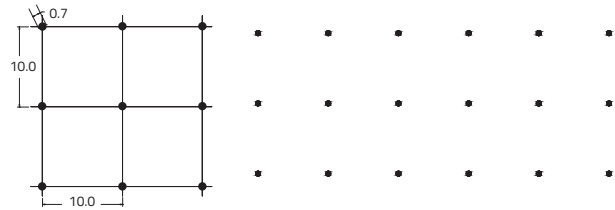

STANDARD PERFORATIONS *FORATURE STANDARD*

A

Ø 2.5 mm = 20% - parallel pitch ▪ *passo parallelo* 5 mm

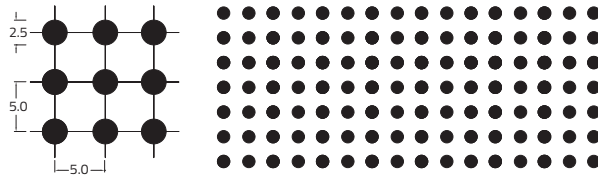

B

Ø 2.5 mm = 7% - diagonal pitch ▪ *passo diagonale* 8.5 mm

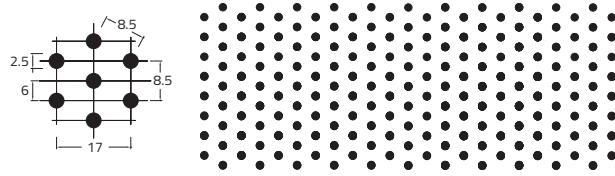

C

Ø 2.0 mm = 6% - diagonal pitch ▪ *passo diagonale* 8 mm

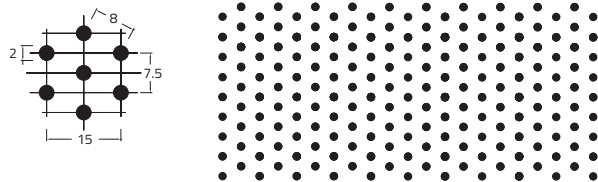

D

Ø 2.0 mm = 12% - parallel pitch ▪ *passo parallelo* 7.5 mm

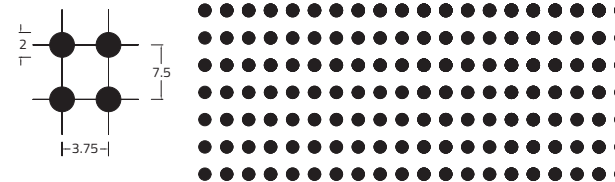

E - AP3

Ø 2.0 mm = 25% - diagonal pitch ▪ *passo diagonale* 3.5 mm

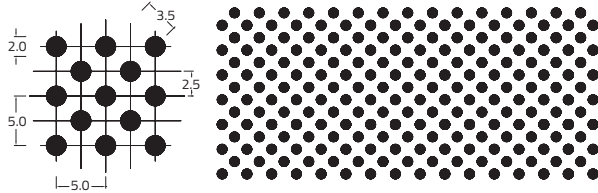

F - AP4

Ø 2.0 mm = 12.5% - parallel pitch ▪ *passo parallelo* 5 mm

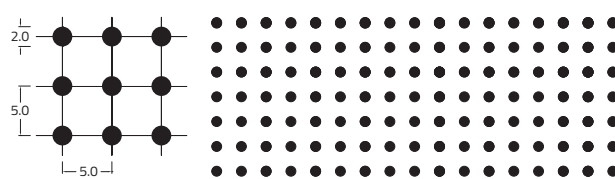

G - APQ2

2 x 2 = 4.5% - parallel pitch ▪ *passo parallelo* 9.5 mm

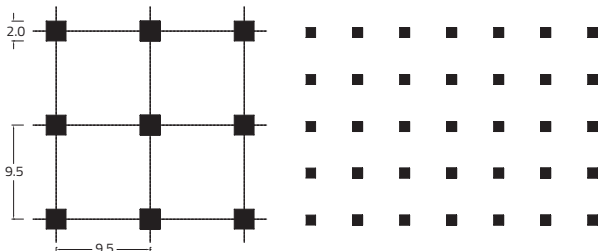

PERIMETRAL MOLDING

standard length 3000 mm

For special dimension perimetral moldings are available

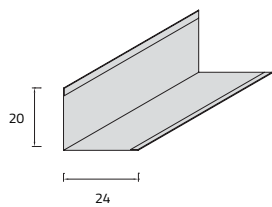

20 X 24
CP10 aluminum 0.5/0.6 mm
A3000 steel 0.5/0.6 mm

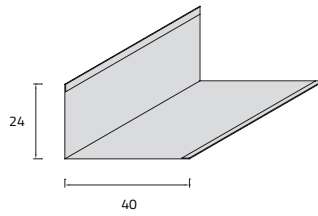

24 X 40
CP20 aluminum 0.5/0.6 mm
A3002 steel 0.5/0.6 mm

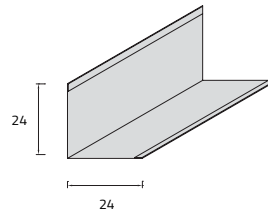

24 X 24
CP11 aluminum 0.5/0.6 mm
A3001 steel 0.5/0.6 mm

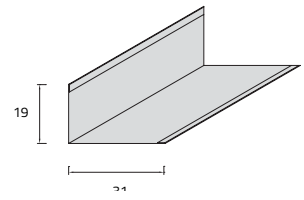

19 X 31
CP30 aluminum 0.5/0.6 mm
A3003 steel 0.5/0.6 mm

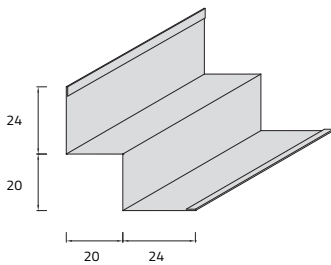

24 X 20 X 20 X 24
CW2020 aluminum 0.5/0.6 mm
W3003 steel 0.5/0.6 mm

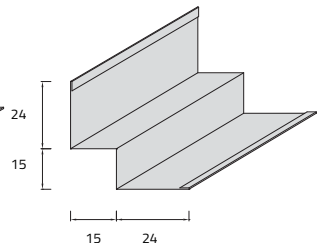

24 X 15 X 15 X 24
CW1515 aluminum 0.5/0.6 mm
W3004 steel 0.5/0.6 mm

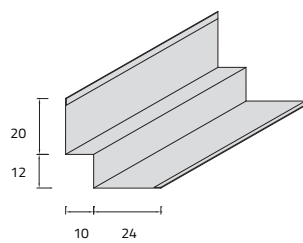

20 X 12 X 12 X 24
CW1210 aluminum 0.5/0.6 mm
W3000 steel 0.5/0.6 mm

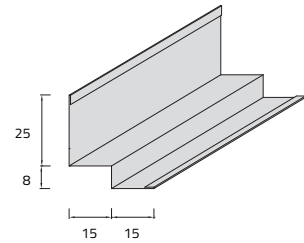

25 X 8 X 15 X 15
CW0815 aluminum 0.5/0.6 mm
W3002 steel 0.5/0.6 mm

COLOURS RANGE

STEEL / ALUMINIUM



white



RAL 9006
silver



RAL 7024
dark grey

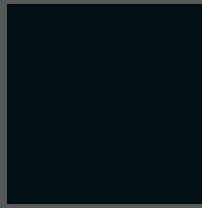

RAL 9005
black



satin-finish aluminium

POWDER COATED



ALL RAL COLOURS

WOOD



SL57
whitened oak



SL56
cherry tree

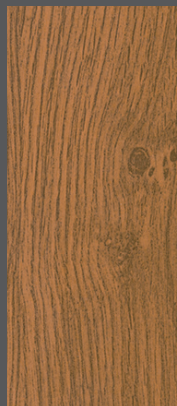

SL252
winchester



SL02
light oak



6869
farm maple

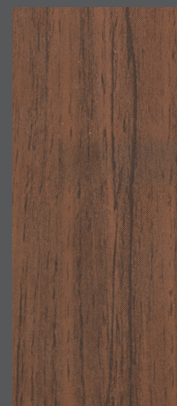

SL28
teak



SL39
dark oak

ALUMINIUM / MAT



RAL 1015
ivory



RAL 1001
beige



RAL 1021
cadmio yellow



RAL 1007
chrome yellow



RAL 2004
orange



RAL 3002
carmine red



navy blue



RAL 5017
blue



RAL 6018
pea green



RAL 6029
mint colour



RAL 8014
brown

ALUMINIUM / BRIGHT



aisi steel
310



brass yellow
330



gold
260

The range of colours shown on this page is purely indicative, and we recommended that you request the samples. For other colours, please ask about the availability in stock.

For further details, refer to the bundle of RAL colours and CBI's exclusive colours bundle, or contact the technical department at CBI Europe.

LINEAR STRIPS: design and functionality, 100% made in Italy.

CBI Europe's Linear Strips suspended ceiling system is the perfect solution for civil and industrial buildings. These highly functional architectural elements combine thermal and acoustic insulation with the ability

to integrate ventilation, lighting and security systems. The fully inspectable strips come in various modular types and designs to allow the suspended ceiling to adapt to all spaces and layouts.



AESTETICH VERSATILITY



LIMITLESS CONFIGURATION



HI-TECH PERFORMANCES

Why

VERSATILE, FUNCTIONAL, LONG LASTING AND EASY TO INSTALL: A PERFECT COMBINATION OF TECHNOLOGY AND DESIGN THAT GUARANTEES HYGIENE AND STRENGTH.

Where

LARGE PUBLIC SPACES - HALLS, SHOPPING CENTRES, AIRPORTS, BANKS, OFFICES, CORRIDORS, STERILE ENVIRONMENTS, THEATRES, CANTEENS, HOSPITALS - OUTDOORS AND INDOORS.

Benefit

- **ACHIEVING FLEXIBLE, COMFORTABLE, CONTEMPORARY AND RESPONSIBLE INTERIORS.**
- **OBTAINING POINTS FOR LEED CERTIFICATION.**
- **SOUNDPROOFED ENVIRONMENTS.**
- **SPEEDING UP CONSTRUCTION.**
- **CONTAINING COSTS OF LABOUR AND MAINTENANCE.**
- **STRUCTURES 100% INSPECTABLE.**
- **INTEGRATION WITH ADVANCED CLIMATE CONTROL, DOMOTICS AND LIGHTING.**
- **PRECISE BUDGETING.**



FIRE REACTION

Including versions incorporating sound-absorbing non-woven fabric, are non-flammable according to the Italian Ministerial Decree of the 15th march 2005, and therefore conform to Euroclass A1 fire reaction requirements (only for not perforated panels).



HYGIENE

Easy to wash and sterilise, non-toxic, humidity resistant, and are ideal for use in kitchens, canteens, hospitals and schools.

On request, they can also be supplied in a special fungicidal and bactericidal paint finish: tests carried out under ISO 22196 ensure the reduction of the microbial population > 95% after 24 hours. They also provide valuable protection against dust in industries producing delicate electronic circuits.



HUMIDITY RESISTANCE

Maintain their dimensional stability even under extreme ambient conditions, and can therefore be installed in environments characterised by high levels of relative humidity and large variations in temperature.

For outdoor installations, please contact CBI Europe's Technical Department.



PAINTWORK

Suspended ceilings in pre-painted aluminium and hot-galvanised and pre-painted FePO2 steel are coil-coated with primer and polyester paint to a thickness of 25 microns.

Suspended ceilings in electro-galvanised and post-painted FePO2 steel are electrostatically coated with resin based, thermosetting, polyester powder paints to a thickness of 60 microns.



LIGHT REFLECTANCE

All metal suspended ceilings finished in white and unperforated > 85% have a standard gloss level of 20.



INTEGRATED ACCESSORIES

All metal suspended ceilings can be fitted with accessories such as lighting units, ventilation vents, smoke detectors, sprinklers and suspended signage



FASTNESS

The systems are designed to guarantee rapid installation, speeding up the installation phases and respecting all the requirements of planarity and orthogonality.



ACOUSTIC ABSORPTION

Ceilings and coverings combine acoustic performance, comfort and aesthetics with adequate absorption values. Upon request they can be supplied with certifications issued by independent companies.



LEED CERTIFICATION

All products are manufactured in certified and constantly monitored processes to guarantee the highest standards of quality and safety.



ANTI-SEISMIC

The systems guarantee the application of all good safety practices in the construction and development of dedicated projects.

Upon request, they can be supplied with an anti-seismic reports, which indicate suitable bracing.