



Solid Linear Wood

HunterDouglas

CEILINGS

**Innovative products
make innovative projects.**



Above : Abingdon Sports Centre, Abingdon, United Kingdom
Architect: Buttress, Fuller, Alsop, Williams
Product : Linear open system 15 x 92 mm
Wood : American yellow poplar

Cover : Terminal Puerto BCN Barcelona, Spain
Architect: Grupo JG
Product : Linear open system 15 x 70 mm
Wood : European pine coloured

AUTHENTIC WOOD, MODERN DESIGN

Let your imagination run free to create the most remarkable, solid wood ceiling designs with Linear Wood system from Hunter Douglas. The system provides extensive design freedom for interior and exterior applications. Concave, convex and undulating sections can easily be formed, thanks to the specially engineered suspension system.

Hunter Douglas Linear Wood ceilings have inspired leading architects from all over Europe to create prestigious projects, such as airports, universities, hospitals, swimming pools and offices.



SYSTEMS & DESIGN 2 - 5

WOOD SPECIES 6 - 7

PRODUCT
AND SYSTEM
SPECIFICATIONS 8 - 11

Flawless details Endless possibilities



SYSTEMS & DESIGN

Hunter Douglas Wood system consists of three basic designs: Linear open, Linear closed and Grid allowing for virtually limitless design options.

- Linear standard width, open or closed, interior or exterior system
- Linear variable width, interior or exterior system
- Grid, interior or exterior system
- Concave, convex or undulating forms
- Horizontal, vertical or inclined ceilings

Designs are available in a wide variety of different wood species. After the architect has formulated the design, Hunter Douglas can assist in bringing the vision to life with our technical support services.



Above : Conservatorium Amsterdam, the Netherlands
Architect: De Architecten Cie, Amsterdam
Product : Linear open system 15 x 74 mm
Wood : American Red Oak

Below : Cultureel Centrum Alblasterdam, the Netherlands
Architect: Abrahamse De Kock Architecten BNA Dordrecht
Product : Grid system 6-40-15-35
Wood : African Ayous

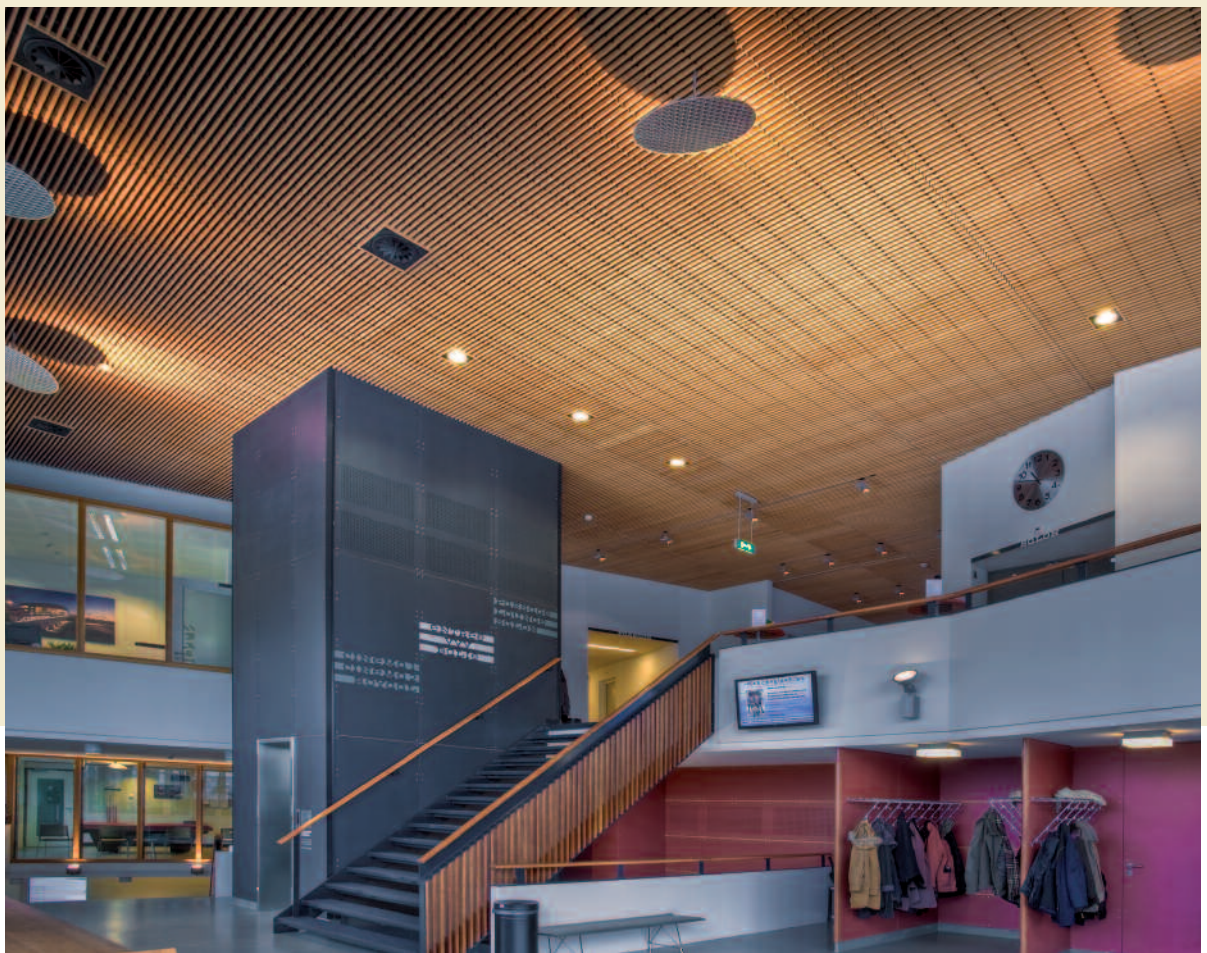



OPEN AND CLOSED LINEAR SYSTEM

The Hunter Douglas Linear solid wooden system is available in both open and closed formats that can be specified as either a fixed or demountable system, allowing easy access into the plenum.

The system's design ensures that the panels remain level and straight in all situations, including large, flat areas, externally and in swimming pool environments.





Left : Union Square, Aberdeen, UK
Architect: BDP
Product : Solid Linear system combined with Grid system
Wood : Western Red Cedar

GRID SYSTEM

The Grid system consists of panels made of solid wooden slats connected to each other with an anodised black aluminium dowel or flexible dowel. Optionally also available in blank anodised aluminium or wooden dowel. Using a male/female dowel connection system ensures the seamless alignment of the panels. The demountable panels are fixed to a black metal grid with a dowel clip.



Above : Wine Cellar, Barcelona, Spain
Architect: Pilar Libano
Product : Grid system
Wood : Western Red Cedar

WOOD SPECIES

There is an extensive choice of wood species available, ranging from the deep warm colours including Western Red Cedar, Merbau or Mahogany to the light wood tones of Poplar, Maple or Ayous. Upon request, we can use almost every kind of wood your design requires. The wood can be finished in transparent lacquer or can be stained in any colour.

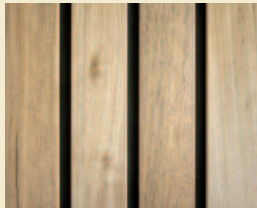

Ayous

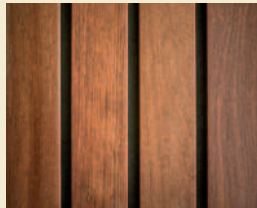

Cambara

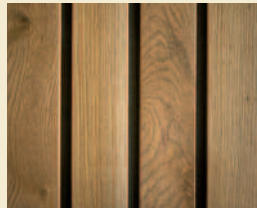

Oak



Ash

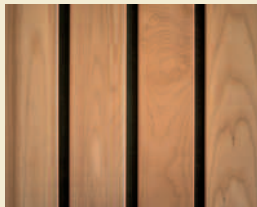

Steamed Beach

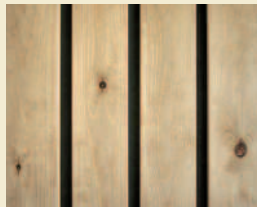

European Pine

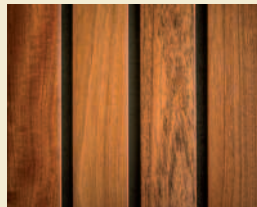

Jatoba

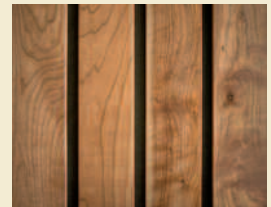

Cherry

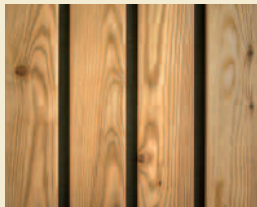

Larch



Mahogany

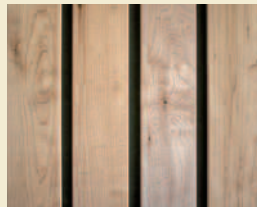

Maple

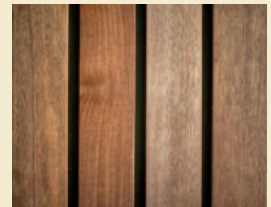

Meranti

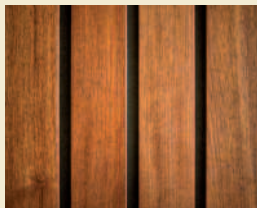

Merbau

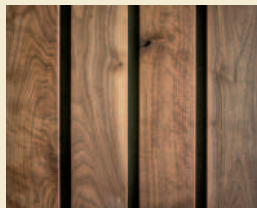

Walnut

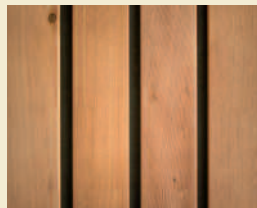

Oregon Pine



Poplar

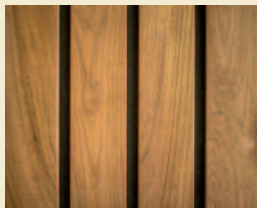

Teak



White Oak

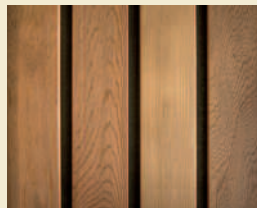

Western Red Cedar



TOUCH OF NATURE

Each piece of wood has its own structure and characteristics and can behave differently. When selecting solid wood for a project you will find natural and authentic touches like growth patterns, notches and colour variations. These effects are typical characteristics of a solid wooden ceiling and result in a naturally beautiful and lively surface.

QUALITY

Hunter Douglas uses only the finest quality of wood in the Wood ceiling system. From raw timber to finished ceiling system, our production process is carried out with the latest computer controlled machinery and closest supervision to ensure a high quality product. Architects and contractors can count on our knowledge and expertise when choosing materials for their ceiling designs.



On request FSC wood can be applied if it is available in the preferred wood specie.

Product and system specifications

LINEAR SYSTEM

Linear Wood from Hunter Douglas is a suspended system consisting of solid wooden panels mounted on a metal suspension rail with clips. The Linear ceiling system consists of two basic designs: Linear open and Linear closed.

1. LINEAR OPEN

The Linear open system panels are supplied in following widths (in mm).

** Standard, other modules are available on request*

STANDARD WIDTHS (MM):

Module	Panel width	Thickness	Joint width
75	63	15	12
82.5	63.5	15	19
85	70	15	15
89	70	15	19
101.6	82.6	15	19
105	92	15	13
111*	92	15	19
125	110	15	15
135*	116	15	19

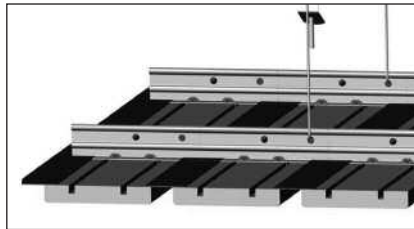

Ceiling application



Wall application

VARIABLE WIDTHS

It is possible to combine panels of different widths into the Linear open system.

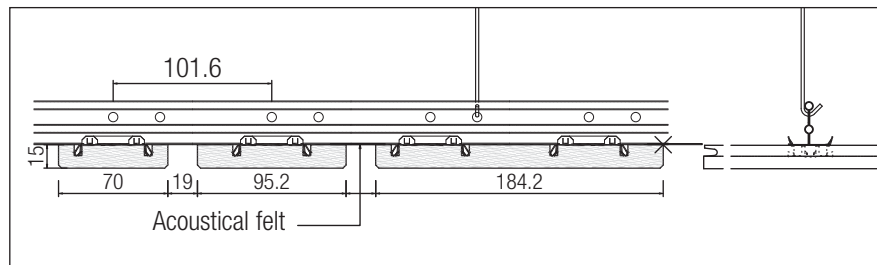

2. LINEAR CLOSED

With the Linear closed system, the panels shi lap over each other to form a closed system.

STANDARD WIDTHS (MM):

Module	Panel width	Thickness	Joint width
89*	96	16	-
111	118	16	-

**Other sizes on request*

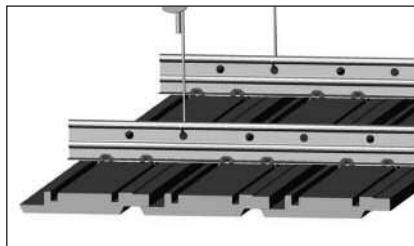

Ceiling application

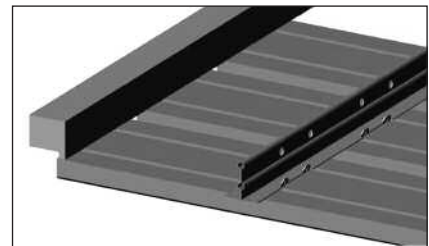

Ceiling with perimeter wood

Product and system specifications

3. LINEAR CURVED CEILING

The Linear closed and open system can easily be installed in concave, convex or undulating curved patterns. The rail is pre-curved in the factory to the specified radius.

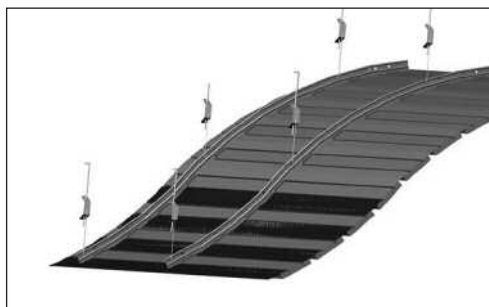

Curved ceiling application

4. LINEAR CONSTRUCTION OF THE PANELS

The wooden panels are available in a variety of different widths and sections. The minimum width for the open system is 63 mm, for the closed system it is 96 mm. The maximum width for both systems is depending on wood specie. The thickness of the panels is minimum 15 mm. An acoustic felt strip can be fixed to the panels in the factory. A maximum of 50% of the ceiling surface can be specified as demountable.

Longitudinal connection

The panels are joined, where necessary, using a tongue and groove connection across the width of the panel. This joint detail is reinforced with a steel fixation pin inserted into the back of the panel.

5. ACOUSTICS

Various acoustic effects can be achieved with the Linear Wood system, depending on the use of the space for which the ceiling is designed. An acoustical felt can be applied to the linear open system. This closes the open joint between the panels and improves acoustic sound absorption.

When installed in an undulating or raked formation, the system achieves a higher level of acoustic absorption. Panels can also be supplied with a plywood infill for exterior installations or a higher level of acoustic reflection.

The table indicates the acoustic test results of an open Linear Wood ceiling with acoustical felt covered with 20 mm thick, 90 kg/m³ acoustically absorptive material.

Frequency (Hz)	125	250	500	1,000	2,000	4,000
Absorption coefficient	0.57	0.83	0.76	0.65	0.47	0.33
NRC-value	0.70					

Values depend on surface, type of ceiling, plenum depth

Product and system specifications

GRID SYSTEM

The grid system consists of wooden slats connected to each other with an anodised black aluminium dowel or flexible dowel. Optionally also available in blank anodised aluminium or wooden dowel. The aluminium or wood are used in straight ceilings, the flexible ones for curved installations. Product parameters provide flexibility for the specifier to determine slat dimension and separation. The open Grid ceiling is very useful in areas that require a high degree of acoustic control.

1. CURVED AND OTHER VARIANTS

The slats can be installed horizontally, vertically or curved, due to the flexible dowel.

CONSTRUCTION

The dowel is pushed through the slats and fixed on the back. The width of the grid panels is dependent of the building design and layout. To ensure that the suspension remains unobtrusive, the rails, dowels and clips are painted black.

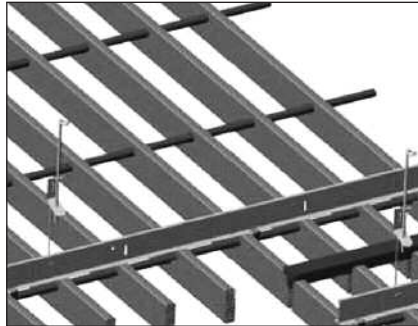

Ceiling application

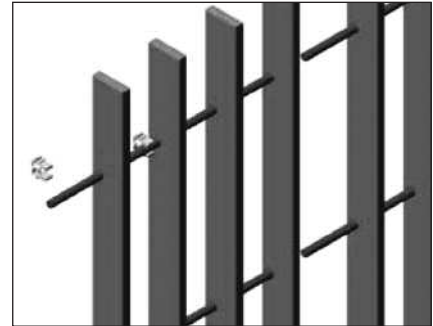

Wall application

MEASUREMENT

A grid panel has a maximum length of 3300 mm. The panel width is between 300 and 400 mm depending on the exact slat dimension and spacing. The minimum distance between the slats is 15 mm, with a maximum slat height of 35 mm. When the slat height is above 35 mm, the minimum measurement is 20 mm.

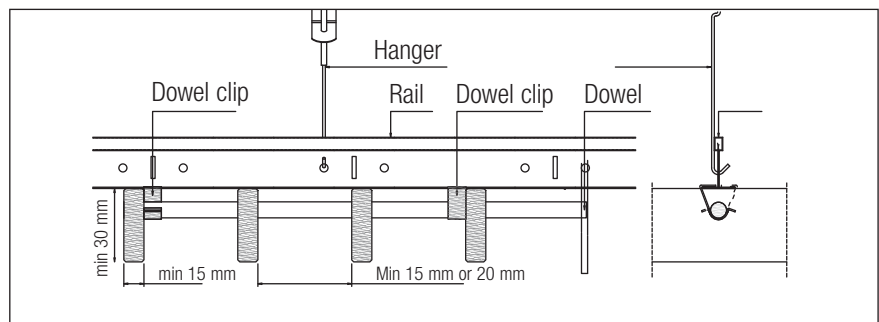

The distance between the dowels is 300 mm. The panels are connected to each other with a male/female dowel intersection which conceals the joint. A gap of 10 mm is formed between one panel and the adjacent panel.

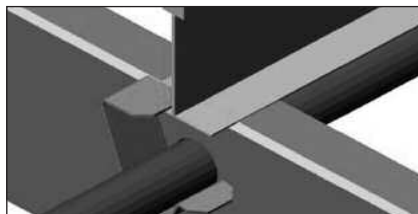
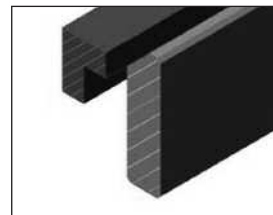

EXAMPLES OF PANEL TYPES

The maximum length of a panel is 3300 mm, depending on wood specie and design.

The diameter of the dowels is 12 mm. Optionally also available in 20 mm.

Panel type	Lath	Joint width	Slat width	Slat height	Panel width
05-45-15-31	5	45	15*	31*	300
07-20-30-35	7	20	30	35	350
10-20-15-55	10	20*	15*	55	350
08-15-30-31	8	15*	30	31*	360

*These are the minimum sizes

General

EXTERIOR CEILING, SWIMMING POOL AND SPORT CEILING

Exterior ceilings, swimming pool and sport ceilings are non demountable in the linear system, but it is possible to provide access areas. Special lacquer protects the wood surface against extreme humidity. Linear Wood is also impact resistant and therefore very popular in sport centres.

SURFACE TREATMENT

Linear Wood can be finished with transparent lacquer or stained to practically any desired colour. The wooden panels can be completely varnished to protect from the influences of humidity and moisture. Standard panels can withstand a relative humidity of up to 70%.

OPTICAL CHARACTERISTICS

Wooden panels can change appearance when exposed to ultraviolet rays.

FIRE RETARDANT

Fire safety is an essential element of every wooden ceiling. The panels are treated with a vacuum pressure method to impregnate with a FR liquid.

Linear Wood achieves the European CE Classification, SBI test, class B, s2, d0. The felt strip fulfils the highest fire retardant requirements for textiles, F1.

INSTALLATION

From the factory, the panels are supplied with a felt strip along one long edge and the rails are supplied with clips according to specified module. At the building site, the rails are fixed at the correct centres and suspended from the structural ceiling using galvanised angle. The wood panels are fixed to the clips on the rail using a clamping tool. The relative humidity should be no more than 65% and the building should be water tight. The panels can not be stored direct on the concrete floor.

MAINTENANCE, OPERATION

Maintenance: Clean with water with a mild synthetic cleaning agent

Repairs: The removable sections allow access into the plenum for maintenance.

MATERIAL

Wooden panels	Any type of wood that is qualitatively suitable for a Linear Wood ceiling
Moisture content wood	8-12% upon delivery
Suspension system	Steel, sendzimir galvanised
Felt strips	Non-flammable. The acoustical felt strip is ventilating
Clips	Spring steel with Geomet coating, fixed or detachable
Clip rails	Sendzimir galvanised steel profile and supplied with notches for the clips

EXTERIOR USE



Exterior building applications need to contend with severe conditions like wind, rain, snow, dirt, vandalism and UV light. Our special wood treatment and our windproof systems ensure durability in applications like canopies, shopping centres and railway/underground stations.

HUNTER DOUGLAS ARCHITECTURAL PRODUCTS

In the last 50 years, we've been fortunate enough to help turn countless innovative sketches into innovative buildings.



Architects, designers, investors and contractors from around the world have taken advantage of Hunter Douglas' unmatched product development, service and support. Chances are, you've seen more of Hunter Douglas than you think.

With major operation centres in Europe, North America, Latin America, Asia and Australia, we've contributed to thousands of high-profile projects, from retail and commercial facilities to major transit centres and government buildings.

Not only are the world's architects and designers our partners, they're our inspiration. They continue to raise the bar for excellence. We create products that help bring their visions to life: Window Coverings, Ceilings, Sun Control Systems and Façades.



Promoting sustainable forest management
www.pefc.org



Hunter Douglas products and solutions are designed to improve indoor environmental quality and conserve energy, supporting built environments that are comfortable, healthy, productive, and sustainable.



The Forest Stewardship Council is an international non-profit organization founded in 1993 to support environmentally appropriate, socially beneficial, and economically viable management of the world's forests.

ARCHITECTURAL SERVICES

We support our business partners with a wide range of technical consulting and support services for architects, developers and installers. We assist architects and developers with recommendations regarding materials, shapes and dimensions and colours and finishes. We also help creating design proposals, visualisations and mounting drawings. Our services to installers range from providing detailed installation drawings and instructions to training installers and advising on the building site.



HunterDouglas

CEILING



HUNTER DOUGLAS is a publicly traded company with activities in more than 100 countries with over 150 companies.

The origin of our company goes back to 1919, in Düsseldorf, Germany. Throughout our history, we have introduced innovations that have shaped the industry, from the invention of the continuous aluminium caster, to the creation of the first aluminium Venetian Blinds, to the development of the latest high-quality building products.

Today we employ more than 16,500 people in our companies with major operation centres in Europe, North America, Latin America, Asia and Australia.

Innovative Products Make Innovative Projects

© Registered trademark - a HunterDouglas® product Pats. & Pats. Pend. - Technical data subject to change without notice. © Copyright Hunter Douglas 2011. No rights can be derived from copy, text pertaining to illustrations or samples. Subject to changes in materials, parts, compositions, designs, versions, colours etc., even without notice. MX600W00

Learn More

- Contact our Sales office
- www.hunterdouglascontract.com



Austria
Belgium
Bulgaria
Croatia / Slovenia
Czechia
Denmark
France
Germany
Greece
Hungary
Ireland
Italy
Kazakhstan
the Netherlands
Norway
Poland
Portugal
Romania
Russia
Serbia
Slovakia
Spain
Sweden
Switzerland
Turkey
Ukraine
United Kingdom
Africa
Middle East

Asia
Australia
Latin America
North America

HUNTER DOUGLAS EUROPE B.V.
2, Piekstraat
P.O. Box 5072 - 3008 AB Rotterdam
The Netherlands
Tel. +31 (0)10 - 486 99 11
Fax +31 (0)10 - 484 79 10
www.hunterdouglascontract.com

HunterDouglas

WINDOW COVERINGS

CEILING

SUN CONTROL

FAÇADES